



LENCO

▶ *WE MAKE THE BEST BOATS BETTER!*



The world leader in
trim tab systems &
hatch lift innovation.

OWNER'S MANUAL



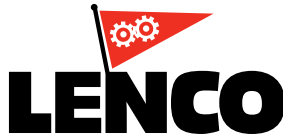

Contents

Trim Tabs & Switches

| | |
|--|-----|
| Glossary & Special Conditions | 2 |
| Trim Tab Operation | 3 |
| Trim Tab Maintenance Tips. | 4 |
| Trim Tab Installation Instructions | 5-7 |
| Switch Installation Instructions. | 8 |

Wiring Diagrams

| | |
|---|------|
| Wiring Diagrams for all Switch & Flybridge Kits | 9-16 |
|---|------|

Bennett Hydraulic-to-Lenco Electric

| | |
|----------------------------------|----|
| Installation & Mounting. | 17 |
| Wiring Instructions | 18 |

Hatch Lifts

| | |
|---|----|
| Hatch Lift Installation & Wiring. | 19 |
| Hatch Lift Mounting & System Parts List | 20 |

Airboat Trim Tabs

| | |
|--|----|
| Airboat Trim Tab Installation | 21 |
| Airboat Trim Tab Switch Wiring | 22 |

| | |
|-----------------------------------|-------|
| General Troubleshooting | 23-24 |
|-----------------------------------|-------|

| | |
|---------------------------|----|
| Warranty Policy | 25 |
|---------------------------|----|

| | |
|---------------------------|----|
| Switch Template | 26 |
|---------------------------|----|

CONGRATULATIONS!

You have just purchased the finest trim tab system in the world! Welcome to the future.

Lenco trim tabs make the single most important difference in the way your boat rides and performs. They are optional on some boats, but should be as standard as power trim and tilt. Lenco trim tabs make your boat ride smoother, drier, faster and with increased safety whether on a small skiff or a mega-yacht. Our ball screw design makes our tabs more reliable and twice as powerful as typical hydraulic trim tabs. Coupled with any of our trim tab switches, they also perform with instant response, which makes them more precise and user-friendly.

Our goal is to manufacture products that simply make boating more enjoyable.

 All Lenco Marine LLC Trim Tab products are CE certified

The contents of this manual are subject to change without notice and do not constitute a commitment on the part of Lenco Marine LLC. Every effort has been made to ensure the accuracy of this document. However due to ongoing product improvement and revision, Lenco Marine LLC cannot guarantee the accuracy of printed material after date of publication nor can it accept the responsibility for errors or omissions. Lenco Marine LLC will update and revise this document as needed. Reproduction or duplication of the manual, or any part thereof is prohibited without the expressed written permission of Lenco Marine LLC, Inc. All rights reserved. © 2019 Lenco Marine LLC.



Visit our website: www.lencomarine.com

GLOSSARY OF TERMS

| | |
|----------------------|--|
| Bow | Front part of a boat |
| Chine | Portion of the hull where the bottom and sides intersect |
| Following Sea | Waves of current running with the course of a boat |
| Head Sea | Waves or current running directly against the course of a boat |
| Helm | Area of a boat where operational controls are located |
| Hull | The main body of a boat |
| Porpoising | When the bow of the boat hops repeatedly while navigating in a straight line |
| Port | The left side of a boat looking forward |
| Starboard | The right side of a boat when looking forward |
| Stern | Rear part of a boat |
| Strake Edge | Points on the bottom of a hull |
| Trailing Edge | The furthest edge from the hinge on a trim tab |
| Transom | The rear section of the hull connecting the two sides |

INSTRUCTIONS FOR SPECIAL CONDITIONS

Following Sea — Make sure the tabs are fully retracted by pressing Bow Up on both sides. This brings both tabs to a fully retracted position, decreasing lift in the stern, allowing the bow to rise. If tabs are deployed, the bow may dig.

Head Sea — Lower both tabs slightly by pressing Bow Down on both sides. This brings the bow down, while maintaining speed. This adjustment allows the hull of the boat to absorb the impact of the waves, resulting in a more efficient and smoother ride.

Porpoising — To stop porpoising, press Bow Down on both sides of the switch. The tabs need only to be deployed slightly to correct this adverse situation.

Shallow Water/Hole Shot — Lower both tabs completely down by pressing Bow Down on both sides. This provides lift in the stern of the boat and keeps the bow down. As you throttle up and the speed increases, raise tabs by pressing Bow Up on both sides.

Uneven Load — If one side of the boat is higher than the other while running, press Bow Down on the switch on that side. This lowers the tab on the listing side (low side) to bring the boat level.

Windy Chop — To raise the windward side of the boat, press Bow Up on that side. If this is not sufficient, press Bow Down on the leeward side of the boat. Do not over trim when attempting this. This allows the windward side of the boat to rise and minimizes spray.

SAFETY

- While the boat is underway, do not move one tab up or down significantly, as this may cause listing.
- While at higher speeds, do not over trim. This causes the bow to lower quickly, resulting in a reduction of speed and may cause the boat to veer.
- When running in a following sea, the tabs should be fully retracted. This allows for optimal performance.
- While operating trim tabs, use caution. Improper use of trim tabs may cause accidents and/or injury.

TRIM TAB OVERVIEW

Trim tabs operate independently of one another, to provide optimal performance by redirecting water flow at the transom of the boat. Lenco Trim Tabs have been designed to improve the overall attitude of a boat. If used properly, Lenco Trim Tabs improve the ride, reduce drag, increase speed and improve the fuel efficiency of your boat.

The operation of Lenco Trim Tabs is basic. The two stainless steel planes are mounted with the actuators on the transom of the boat. When the tabs are lowered, the water flow is redirected, creating an upward force at the stern of the boat. When the stern rises, the bow will lower.

Since Lenco actuators are electromechanical, they provide an immediate response at the touch of the switch. This applies to all of our trim tab switch kits. All Lenco switches are based on the position of the bow. The left side of the switch controls the starboard tab. The right side of the switch controls the port tab. The system is set up this way to minimize the guesswork while underway.

Since all boats are different in weight, length, speed and performance, it takes practice to understand how your boat reacts with trim tabs installed. Lenco Trim Tabs allow your boat to get on plane faster and continue planing at lower speeds. This improves visibility and the overall safety of your boat. When making adjustments with the trim tabs, use short momentary taps of the switch.

To become knowledgeable on how your boat performs with Lenco Trim Tabs, remember, practice makes perfect.

Without Trim Tabs



With Trim Tabs



When the tabs are lowered, the water flow is redirected, creating an upward force at the stern of the boat.

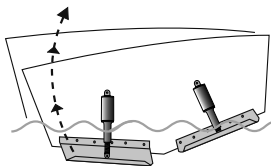

SWITCH OVERVIEW

The operation of all Lenco switches is based on the position of the bow. To lower the starboard bow, press the right (starboard) side of the switch where it reads Down. This lowers the port tab. To lower the port bow, press the left (port) side of the switch where it reads Down. This lowers the starboard tab.



Standard Integrated Switch

The Standard switch was made to work with 12 and 24-volt systems. As described above this maintenance-free tactile switch is based on the position of the bow. Unlike our LED Indicator switch kits, our Standard Switch Kits have no indicator showing how far each tab has moved.

LED Integrated Switch with Self Check Feature

On the Indicator switch, the L.E.D. lights on the sides of the display show how far that tab has moved. When power is applied, the L.E.D. displays on the indicator switch will light up from top to bottom and immediately extinguish from bottom to top to indicate self test at power up. If there is a problem with an actuator connection, the L.E.D. displays shows every other red light "ON" at the side that has the problem (see page 23). After self test is complete (1 to 2 seconds) the L.E.D. displays show one up arrow on each side of the switch. This shows that both tabs are fully retracted. While operating the tabs, the L.E.D. displays indicate the position of the tabs by lighting up the further they are pressed down. As the switch is pressed up, the lights go out. When power is removed from the switch, the tabs retract from any position before powering down.

Self-Check for the LED Indicator

PORT SIDE FAULT



STARBOARD FAULT



BOTH SIDES FAULT



Trim Tab Maintenance Tips

CLEANING YOUR TRIM TABS

The attractive surface appearance of stainless steel cannot be regarded as completely maintenance-free. Our 304 Series Stainless Steel may in fact stain, discolor, or accumulate a layer of surface contamination (dirt and grime) during the normal course of the life cycle. Minute particles of dust and rust may adhere to the stainless steel during shipping, installation, or storage at OEM or retail locations. Also, please remember that some types of stainless steel fasteners tend to “bleed” over the tabs and onto the boat. To achieve maximum corrosion resistance, the surface of the stainless steel must be kept clean and free of all of these contaminants.

Note: Please follow the recommendations for stainless steel cleaning products from your preferred marine retailer. 

PAINTING YOUR TABS AND ACTUATORS with marine antifouling paint will discourage marine algae or growth from adhering to these surfaces.

- Please follow the recommendations for stainless steel antifouling paint from your preferred marine retailer. 
- When applying paint to the actuators, be sure that they are in the fully retracted position. Do not paint the stainless steel ram above the area that is exposed when retracted.
- Do not paint under the anode or the anode itself.

SACRIFICIAL ANODES FOR YOUR LENCO STAINLESS STEEL TRIM TABS

Be aware that stray currents in your marina or in a visiting marina can cause damage to your trim tab blades if not protected by sacrificial anodes.

- The addition of anodes on each tab will deter electrolysis.
- Do not paint under the anode or the anode itself.
- Check Anode condition frequently. Clean and replace as needed.

ELECTROLYSIS IS NOT A MANUFACTURING DEFECT AND IS NOT WARRANTABLE

For more information on electrolysis, please visit www.lencomarine.com and go to the troubleshooting section.

VISUAL INSPECTION OF SYSTEM

- Periodically inspect all wires, mounting brackets, and hardware for damage.
- Make sure all mounting brackets and hardware are secure and working properly.
- Periodically test system for smooth operation.

Trim Tab System Installation Instructions

Warning: The following instructions contain important safety information and should be followed carefully. Failure to do so may result in injury and will void warranty.

Please read through the instructions in their entirety prior to beginning installation!

Note: Measurements may vary from transom to transom.



TOOLS AND MATERIALS LIST

- Electric drill
- Tape measure
- 3/16" & 3/8" drill bits (.48 & .95 cm)
- 7/16" (1.11 cm) wrench
- At least (2) 1/2" wrenches or sockets
- 4' straight edge or level
- 2 1/16" (5.24 cm) hole saw
- #2 & #3 Phillips screwdrivers
- Marine adhesive caulking
- Wire crimper / cutter
- Heat gun

Installation of Trim Tab Blades

- To begin, determine where the Lenco Trim Tab Kit will be installed. Note: When determining the desired tab location, hold the tab against the transom with the bottom of the hinge knuckle 3/8" (.95 cm) up from the bottom of the transom, approximately 1" to 4" (2.54 to 10.16 cm) in from the chine, and parallel with the hull.

Note: The reason the hinge knuckle is mounted 3/8" (.95 cm) from the bottom of the transom is to allow water to continue to travel freely along the bottom of the boat past the transom edge. Tabs are also mounted in this manner for protection while on a boat trailer or when being dry-stored.

When mounting the hinge to the hull, make sure that the inside corner of the hinge knuckle is no closer than 2" (5.08 cm) to the left or right of any strake edge. The hinge may overlap a strake edge as long as the corner of the hinge knuckle is no closer than 2" (5.08 cm) to the left or right of the strake edge (see Fig.1). Transfer (trace) the hinge screw hole pattern onto the transom for drilling.

Note:

All Performance Series kits with single-tapered blades should be mounted with the tapered side facing toward the center of the boat.

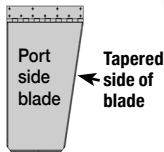

Note: When drilling out the screw hole pattern for the trim tab hinge, you may drill through the transom. Hinge screws should be installed with Marine adhesive caulking, which will seal the holes. All supplied screws and fasteners are stainless steel. Do not use any other type of alloy.



Mount the trim tab hinge to the transom using provided #14 x 1-1/4" (3.18 cm) stainless steel sheet metal screws. We recommend using Marine adhesive caulking to bed the hinge and screws. **DO NOT OVERTIGHTEN.**

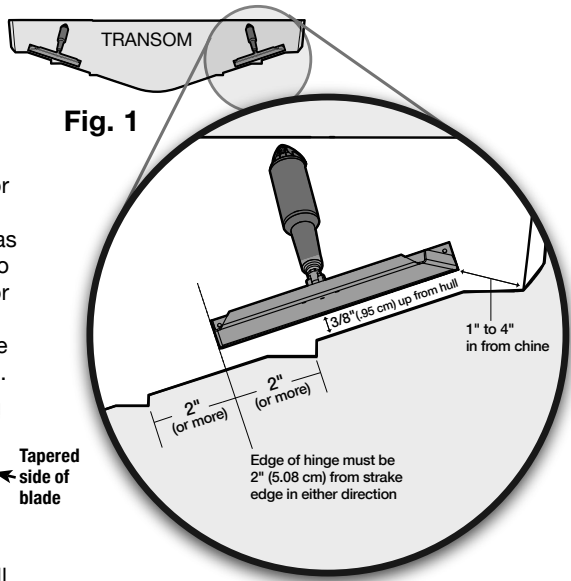

Installation of Upper and Lower Mounting Brackets & Actuators

- Loosely attach the upper mounting bracket (bracket with four holes) to the top of the actuator, using the 5/16-18" X 1-3/4" (4.45 cm) large hex head bolt and 5/16-18 hex nut provided. Attach the actuator to the 119 lower mounting bracket, using the 5/16-18" X 1-3/4" (4.45 cm) large hex head bolt and 5/16-18" hex (.79 cm) nut provided. Attach the 119 lower mounting bracket to the tab with the bolts, washers, and nylon lock nuts provided (Kit# 4 - Part# 10000-001) (see Fig. 2). For new 120 Lower Bracket installation diagram (see Fig. 3).

Fig. 2

119 Lower Bracket Installation

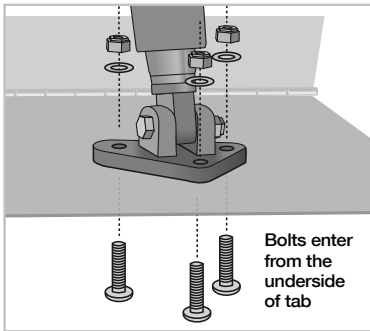
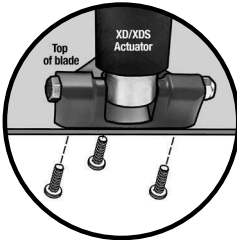

Fig. 3

120 Lower Bracket Installation

Top of Blade Diagram

You must use the supplied hardware provided by Lenco Marine.



Bottom of Blade Diagram

The hardware provided has specific lengths and lock-tight pre-applied to fasteners.

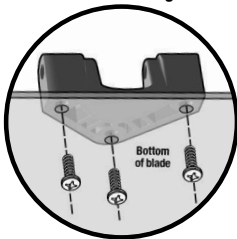

- In order to properly position the upper mounting bracket against the transom, you must lift the trim tab so that the trailing edge is at the recommended height, per the blade length, above the straight edge when held to the hull (see Fig. 8 on pg 7). When the trim tab is at the appropriate level and the actuators are fully retracted, transfer (trace) the outer shape of the upper mounting bracket onto the transom. The upper mounting bracket should be marked where it lays naturally against the transom, to prevent binding during functioning of trim tabs. The upper mounting bracket and the trim tab blade should always be on the same plane when being attached to the transom. When installing Standard Mount kits, the distance from the bottom of the transom to the top of the upper mounting bracket should never exceed 14" (35.6 cm) (see Fig. 4). When installing Edge Mount kits with 9" tab length, the distance from the bottom of the transom to the top of the upper mounting bracket should never exceed 13.5" (34.29 cm). All other Edge Mount kits have an 11" (27.94 cm) maximum distance (see Fig. 5).

Fig. 4

Standard Mount

14" (35.6 cm) max. height needed for actuator

Fig. 5

Edge Mount

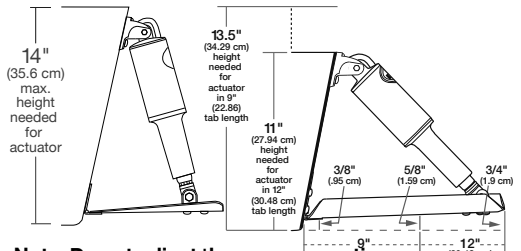

Note: Do not adjust the upper mounting bracket to the right or left, as this will cause binding. Allow the bracket to come to rest at its natural position.

Remove the upper mounting bracket from the actuator and align to the previously marked location to mark the upper mounting bracket screw hole locations and cable hole location. Using the 3/16" (.48 cm) drill bit, drill the three previously marked screw hole locations to a depth of 1-1/4" (3.18 cm).

Warning: With some installations, fuel, water tanks and/or other systems may prevent the actuator cable from entering the hull through the upper mounting bracket. Be sure to check inside the hull before drilling the cable hole.

Note: When drilling out the screw hole pattern for the upper mounting bracket, you may drill through the transom. The screws should be installed with Marine adhesive caulking which will seal the holes when installed. All supplied screws and fasteners are stainless steel. Do not use any other type of alloy.

If all is clear, use the 3/8" (.95 cm) drill bit and drill the previously marked cable hole completely through the transom. Insert the actuator cable through the appropriate hole in the upper mounting bracket until the mount reaches the actuator. Insert the actuator cable through the gland seal until it reaches the rear of the upper mounting bracket (see Fig. 6).

Fig. 6

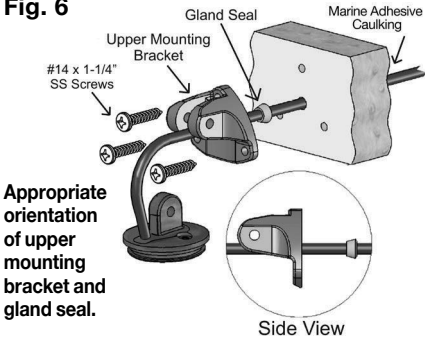

Appropriate orientation of upper mounting bracket and gland seal.

If, however, you are prevented from drilling a hole through the transom at the bracket location, using the 3/8" (.95 cm) drill bit, simply drill a 3/8" (.95 cm) hole 4" to 5" (10.16 to 12.7 cm) above the waterline and insert the cable. Cover the hole and cable with our suggested 15084-001 Remote Gland Seal Kit (see Fig. 7).

Insert the actuator cable through the transom. With the actuator loosely supported, start the provided #14 x 1-1/4" (3.18 cm) stainless steel sheet metal screws through the upper mounting bracket holes and into the transom.

Fig. 8

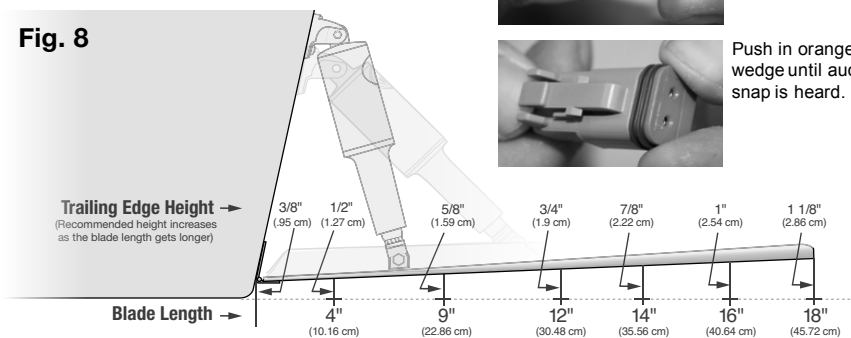
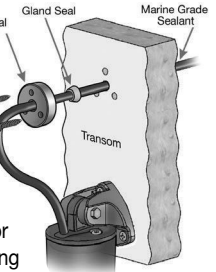

Fig. 7

MAKE SURE TO LEAVE THE SCREWS ONLY PARTIALLY INSTALLED.

Insert the actuator clevis (mounting ear) into the upper mounting bracket and hold the actuator in the approximate installed position. Pass the actuator cable through the transom, removing slack on the cable until it looks like the installation on (Fig. 4 & 5 on page 6).



Finish installing the previously started #14 x 1-1/4" (3.18 cm) stainless steel sheet metal screws through the upper mounting bracket and into the transom. We recommend using Marine adhesive caulking to bed the upper mounting bracket and screws. **DO NOT OVERTIGHTEN.**

Attach and secure the actuator to the upper mounting bracket using the 5/16-18 X 1-3/4" (4.45 cm) large hex head bolt and 5/16-18 (.79 cm) hex nut provided.

We recommend using Marine adhesive caulking to seal the cable hole on the inside of the transom.

Assemble the Deutsch connections to the actuator wire pins as instructed below. Attach the actuator extension cables to the actuator's Deutsch connectors. Then run the actuator extension cables through to the backside of the anticipated mounted switch location.

DEUTSCH CONNECTION ASSEMBLY INSTRUCTIONS

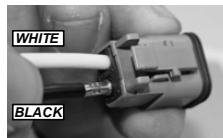

Insert white wire into #1 grommet hole and black wire into grommet hole #2. Make sure to insert wires until contacts lock in place.



Once both contacts are in place, insert orange wedge as shown.



Push in orange wedge until audible snap is heard.

(ALL-IN-ONE) Integrated Switch Installation

Installation instructions for Standard, LED Indicator and LED Dual Ram Indicator Switches.

1. At the helm, determine where the tactile key pad will be installed, locate the template on the inside back cover, and secure to helm. Cut a circular opening using a 2 1/16" (5.24 cm) hole saw (Hole must be 2 1/16"). Before cutting, make sure the area inside the helm is clear of wires and other equipment that could be damaged.
2. Place the key pad & wiring into 2 1/16" hole, feed wires through bezel nut and hand tighten the key pads bezel nut onto the backside of helm.
3. Each switch kit has a retractor wire (orange) that must be connected to an on/off power source. The tabs retract to the up position when power, or analog signal is removed, and then shuts the system down into stand-by mode. You have several connection options from which to choose depending on your boating / fishing needs:

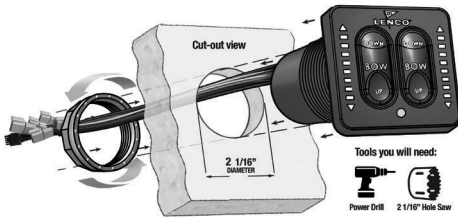

Orange Wire Connection Options

- Connect to Key switch or ON/OFF power source. Do not install the orange wire and main power on the same mechanical switch.

(TWO-PIECE) Tactile Switch Installation

Installation instructions for Standard, LED Indicator and LED Dual Ram Indicator Switches.

1. At the helm, determine where the tactile key pad will be installed, locate the template on the inside back cover, and secure to helm. Cut a circular opening using a 2 1/16" (5.24 cm) hole saw (Hole must be 2 1/16"). Before cutting, make sure the area inside the helm is clear of wires and other equipment that could be damaged.
2. Place the Key pad & wiring into 2 1/16" hole, feed wires through bezel nut, and hand tighten the key pads bezel nut onto the backside of helm.
3. Install the black control box (hardware not included) within 24" (60.96 cm) of the key pad hole. Make sure control box is mounted on a vertical surface with wires facing down toward the deck. Mounting the control box in the incorrect orientation will void the warranty.

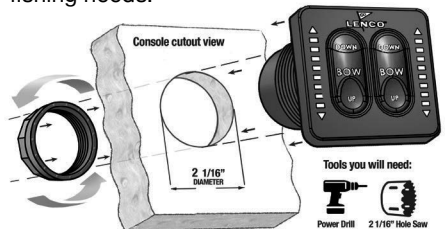

Orange Wire Connection Options

- Connect to Key switch or ON/OFF power source. Do not install the orange wire and main power on the same mechanical switch.

4. After mounting the control box, feed the communication cable from the control box up to the key pad Molex connector and plug together. Leave adequate slack in the connection so the Molex plug doesn't bind or try to separate. No slack or the tightly bundling of the wires can cause damage to the key pad Molex plug!
5. Following the trim tab switch wiring diagram on **pages 14-15**, connect the actuator wire leads, or the actuator extension cables to the switch control box. Be very careful of sharp edges that may damage the cables. Remember the left side of the key pad controls the right (starboard) tab and the right side of the key pad controls the left (port) tab. Red tracer wires go to port actuator(s) and Green tracer wires go to starboard actuator(s).

6. Each switch kit has a retractor wire, (orange) coming from the control box, that must be connected to an on/off power source. The tabs retract to the up position when power or analog signal is removed, and then shuts the system down into stand-by mode. You have several connection options from which to choose depending on your boating/ fishing needs:

Double Rocker Switch (122) Installation

This switch kit does not require a control box. Please follow the wiring diagram for installation instructions. See the switch cutout template the inside back cover (**see diagrams on pg 9 & 10**).

Double Rocker Trim Tab Switch - 122 (Single Actuator)
 Wiring Diagram - Part # 10222-211

10222-211

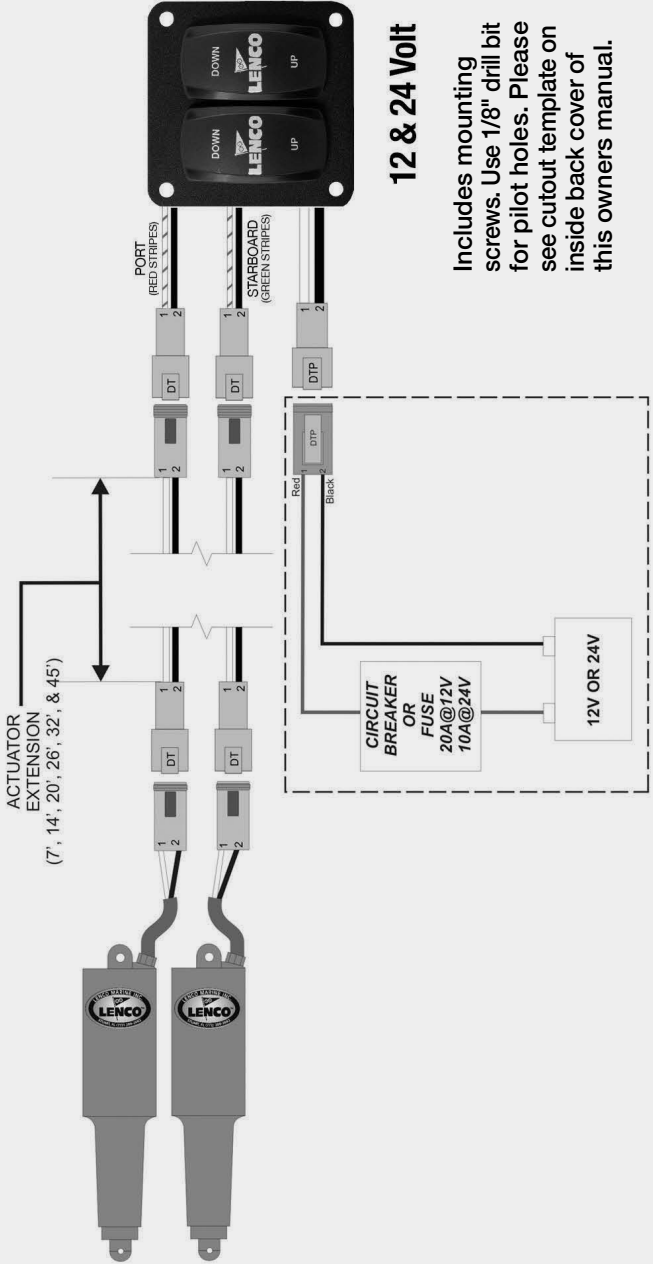

12 & 24 Volt

Includes mounting screws. Use 1/8" drill bit for pilot holes. Please see cutout template on inside back cover of this owners manual.

Double Rocker Trim Tab Switch - 122 DR (Dual Actuator)

Wiring Diagram - Part # 10221-211



10221-211

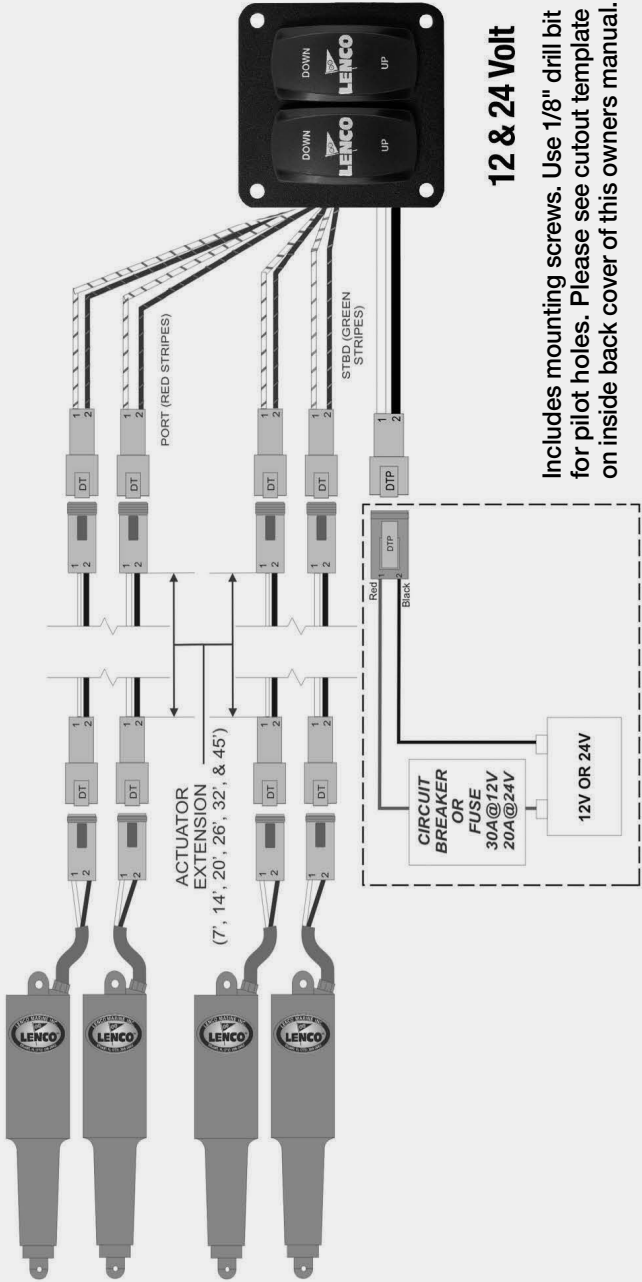

12 & 24 Volt

Includes mounting screws. Use 1/8" drill bit for pilot holes. Please see cutout template on inside back cover of this owners manual.

Standard Integrated Switch Kit with Pigtail for Single Actuator Systems
 Wiring Diagram - Part # 15169-001



15169-001

NOTE: See cutout template on inside back cover of this owners manual.

Flybridge cable for adding a second station standard key pad

ACTUATOR EXTENSION (7', 14', 20', 26', 32', & 45')

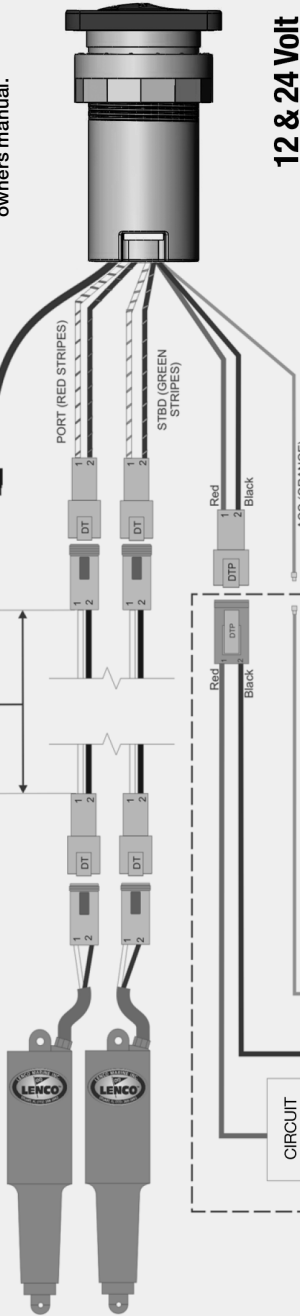

12 & 24 Volt

RETRACTOR WIRE
 Orange wire must be connected to an ON/OFF power source.

This product must be wired exactly as shown above. Failure to wire the trim tab retractor as shown will cause the cancellation of all warranties by the manufacturer.

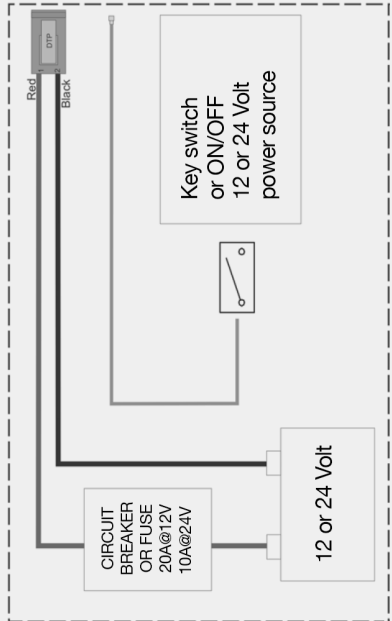

LED Integrated Switch Kit with Pigtail for Single Actuator Systems with Retractor and Self-Check Feature
 Wiring Diagram - Part # 15170-001



15170-001

NOTE: See cutout template on inside back cover of this owners manual.

Flybridge cable for adding a second station LED key pad

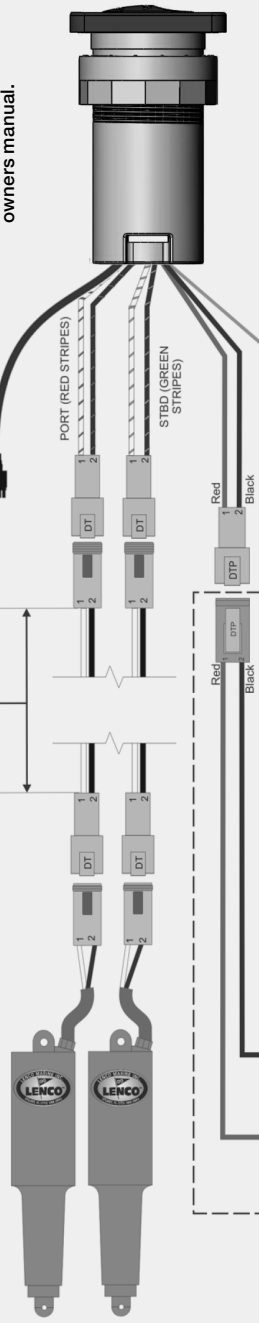

12 & 24 Volt

RETRACTOR WIRE
 Orange wire must be connected to an ON/OFF power source.

This product must be wired exactly as shown above. Failure to wire the trim tab retractor as shown will cause the cancellation of all warranties by the manufacturer.

ACTUATOR EXTENSION (7', 14', 20', 26', 32', & 45')

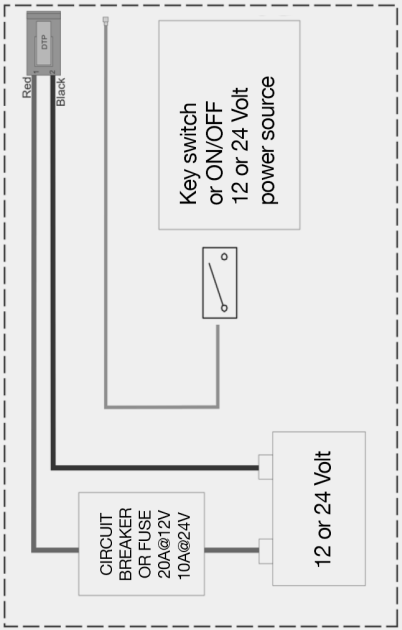

LED Integrated Switch Kit with Pigtail for Dual Actuator Systems with Retractor

Wiring Diagram - Part # 15171-001



15171-001

Flybridge cable for adding a second station LED key pad

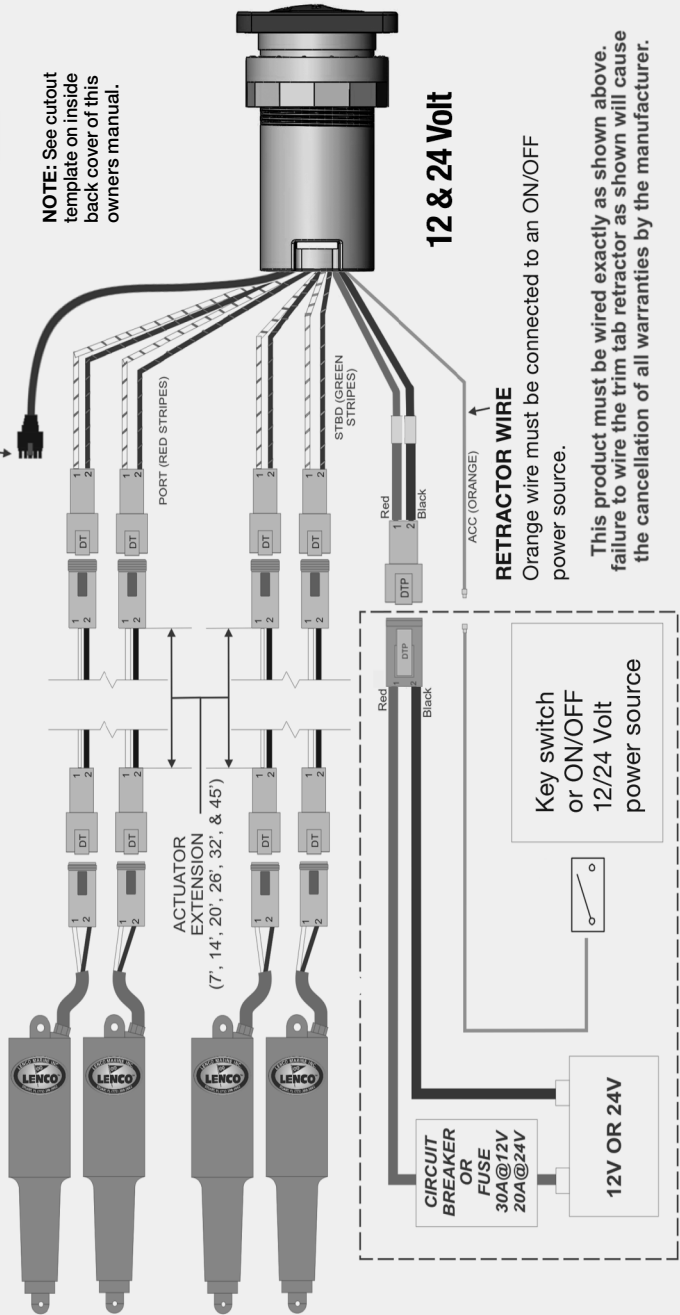

LED (TWO-PIECE) Switch Kit with Pigtail for Single Actuator Systems with Retractor and Self-Check
 Wiring Diagram - Part # 15270-001

Note: In all cases, make sure the control box is mounted with the wires facing down toward the deck.

ACTUATOR EXTENSION
 (7', 14', 20', 26', 32', & 45')

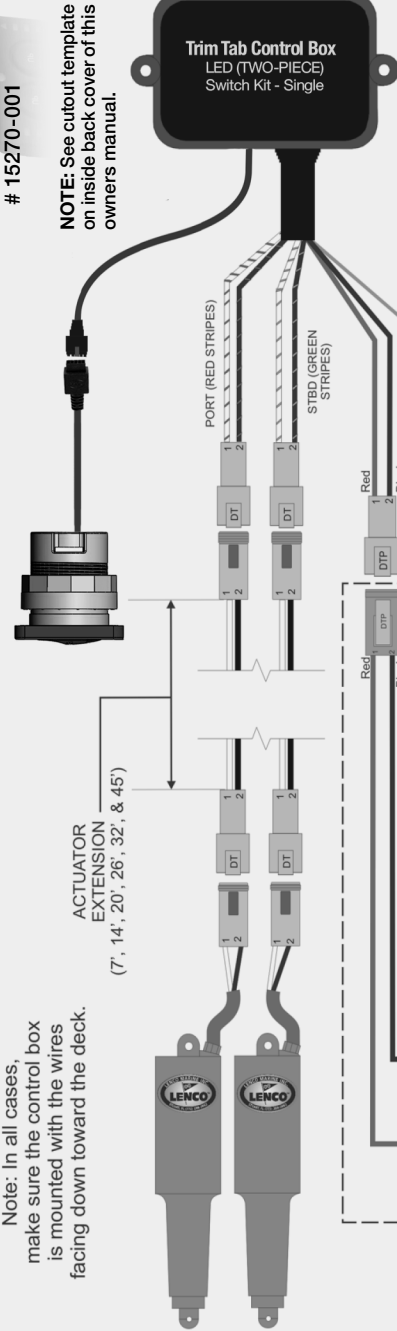

15270-001

NOTE: See cutout template on inside back cover of this owners manual.

12 & 24 Volt

RETRACTOR WIRE

Orange wire must be connected to an ON/OFF power source.

This product must be wired exactly as shown above. Failure to wire the trim tab retractor as shown will cause the cancellation of all warranties by the manufacturer.

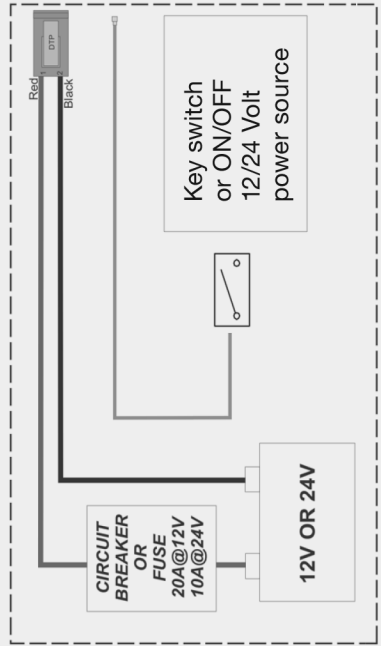

LED (TWO-PIECE) Switch Kit with Pigtail for Dual Actuator Systems with Retractor

Wiring Diagram - Part # 15271-001

Note: In all cases, make sure the control box is mounted with the wires facing down toward the deck.

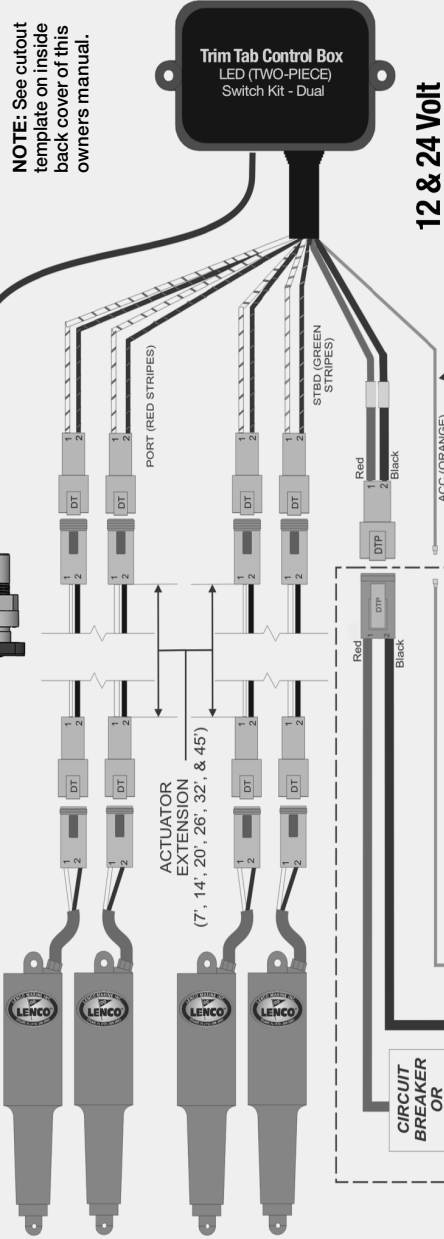

15271-001

NOTE: See cutout template on inside back cover of this owners manual.

12 & 24 Volt

RETRACTOR WIRE

Orange wire must be connected to an ON/OFF power source.

This product must be wired exactly as shown above. Failure to wire the trim tab retractor as shown will cause the cancellation of all warranties by the manufacturer.

Kit Flybridge standard ou commande à LED connecté au nouveau kit de commutateur intégré (tout en un)

Schéma de câblage- Voir N° de pièces ci-dessous

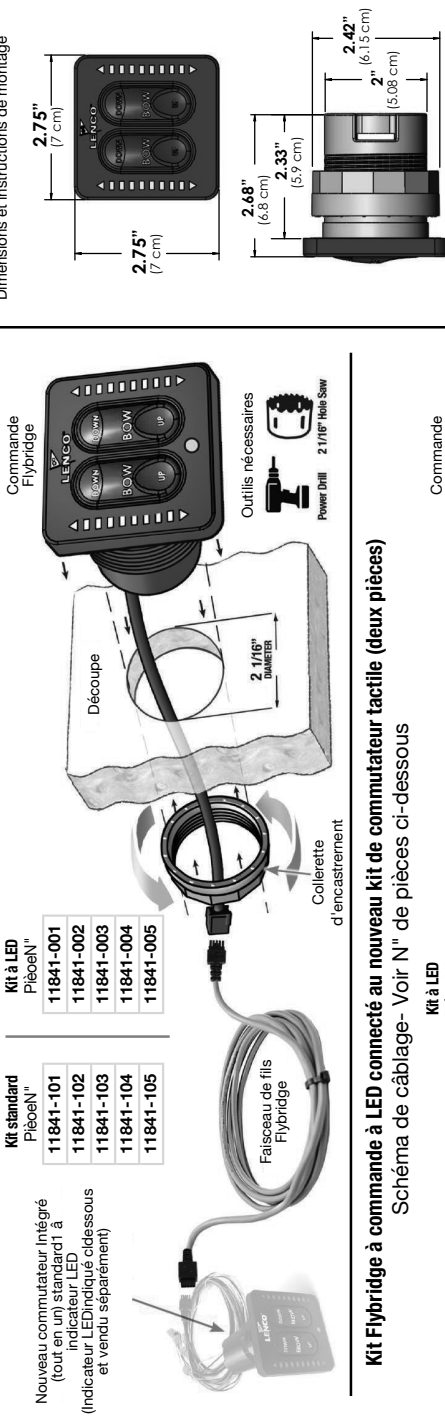

Kit Flybridge standard ou commande à LED
Commande et collerette d'encastrement
Dimensions et instructions de montage

Kit Flybridge à commande à LED connecté au nouveau kit de commutateur tactile (deux pièces)

Schéma de câblage- Voir N° de pièces ci-dessous

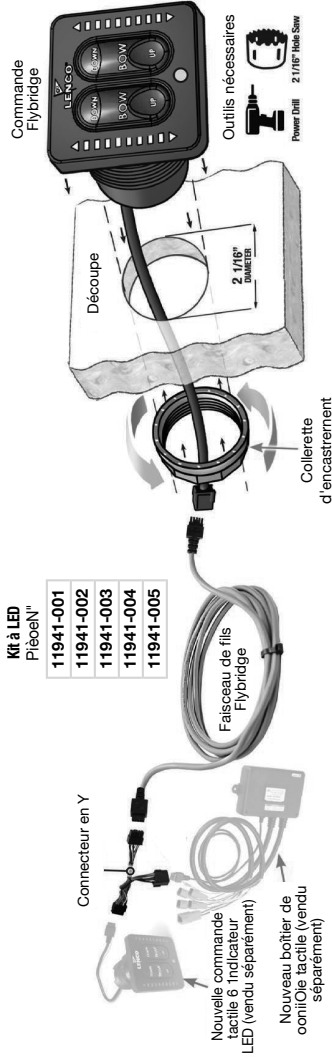

Alignez la mèche centrale d'une scie doche de 2 1/16" (5,24cm) sur la réticule de visée située au centre de l'emplacement de montage souhaité et percez sur toute l'épaisseur de la console pour permettre les connexions électrique et du commutateur. Insérez le commutateur dans le trou de découpe de la console, puis serrez la collerette d'encastrement à la main, dans le sens horaire, à l'arrière de la commande.

NOTE: See cutout template on inside back cover of this owners manual.

Retrofit Kit for Bennett Trim Tabs Installation Instructions

This kit is designed as a direct replacement for the Bennett hydraulic power unit on systems using Bennett's 4-ring standard trim tab actuators. **Note: Bennett Joystick Control can not be retrofitted to the Lenco Actuators.** These instructions should be followed completely. See page 5 for complete Tools and Materials List.

Make sure the power is removed from the Bennett Trim Tab System before installation.

Pre-Installation Instructions

- 1) Disconnect the Bennett hydraulic pump unit (HPU) from the Bennett wiring harness and drain as much of the hydraulic fluid as possible into a container for proper disposal later. Remember that automatic transmission fluid (ATF) is to be disposed of only at an approved collection site in your area; do not discard in the regular trash. Discard hydraulic pump unit (HPU). **Leave Bennett wiring harness in place.**

- 2) Remove and discard the Bennett trim tab cylinders from the boat transom, and remove the hydraulic line at the connection. It helps to have several rags handy to soak up the oil. Remove and discard old hydraulic lines.

- 3) Disconnect the Bennett cylinder from the trim tab plane by tapping out the small black pin at the base of the cylinder, where it attaches to the plane. You will first have to remove one screw from the lower mounting bracket, as this holds the pin in place. **Do not remove the lower mounting bracket, as you will need it later.**

Installation Instructions

- 4) Insert the actuator cable through the appropriate hole in the upper mounting bracket, (supplied with the kit) until it reaches the actuator. Insert the actuator cable through the gland seal until it reaches the upper mounting bracket.

Note: For appropriate orientation of upper mounting bracket and gland seal, (see Fig 1).

You will need to clean the mounting surfaces on the transom with a cleaning solvent, such as mineral spirits or alcohol, to remove all oils and dirt before final mounting.

Insert the actuator cable through the transom. With the actuator loosely supported, bed the upper mounting bracket and screws with Marine adhesive caulking. Start the provided #14 x 1-1/4" (3.18 cm) stainless steel sheet metal screws through the upper mounting bracket and into the transom. **MAKE SURE TO LEAVE THE SCREWS ONLY PARTIALLY INSTALLED.**

Insert the actuator clevis (mounting ear) into the upper mounting bracket and hold in the approximate installed location. Pass the actuator cable through the transom removing slack on the cable until it looks

like the installation on (Fig. 1). Remove the actuator from the upper mounting bracket and finish installing the previously started #14 x 1-1/4" (3.18 cm) stainless steel sheet metal screws through the upper mounting bracket and into the transom.

We recommend using Marine adhesive caulking to bed the upper mounting bracket and screws.

DO NOT OVERTIGHTEN.

Attach the actuator to the upper mounting bracket using the 5/16-18 X 1-3/4" (4.45 cm) large hex head bolt and 5/16-18 (.79 cm) hex nut provided.

- 5) You are now ready to attach the Lenco Actuator to the blade. First, insert the 1-1/4" Delrin Pin part way through the hole in the Bennett lower mounting bracket and insert through one of the four black washers provided in the kit. Place the actuator into the bracket and tap the pin through. Continue through the second washer and other side of the bracket. Replace the bracket screw removed in step 3. This will lock the pin in place and prevent it from falling out.

- 6) Now you will need to hook up the Lenco Actuator wires inside the bilge/rigging area. First, cut the wire connector from the Bennett wire harness where the pump used to be. Strip the four harness wires and connect to the four Lenco wires using the heat shrink butt splices provided in the kit. Make sure to use the proper crimping tool, and then heat all connections for a tight waterproof seal. Tie-wrap or secure in some fashion to a dry location to help prevent the connectors from getting too wet.

Fig. 1

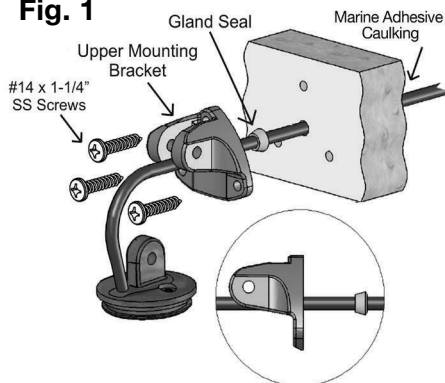

Wiring Instructions For Connecting Lenco Actuator Wires to Existing Bennett Rocker Switch

- 7) Disconnect all wires from the Bennett rocker switch. Remove and discard all brass strips. Reconnect the four wires from the existing Bennett wire harness to the back of the Bennett switch (see Fig. 2).
- 8) Now find a 12 volt negative at the helm/console. Connect this to the 3' black jumper wire with the non terminated end. Attach to screw terminal on the back of the Bennett switch as per the diagram to the right (-12 Volt Black). Attach the orange, black, yellow, red, green, and blue short jumper wires to the back of the Bennett switch, as per the diagram to the right. The 12 volt positive (+) should already be at the switch from the previous system. Simply reconnect it as per the diagram below.
- 9) Test the trim tabs for proper operation. Remember that the right switch controls the left trim tab, and the left controls the right. Bow down should extend the tabs while bow up should retract them.  If, for some reason, this does not work as described in the above text, then recheck all the wiring for a misplaced wire. If still not fully operational, refer to the trim tab trouble shooting guide in the owner's manual for further instructions.

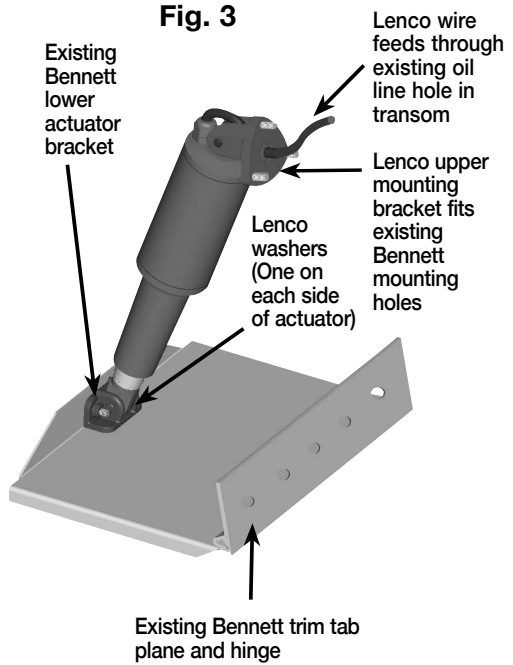
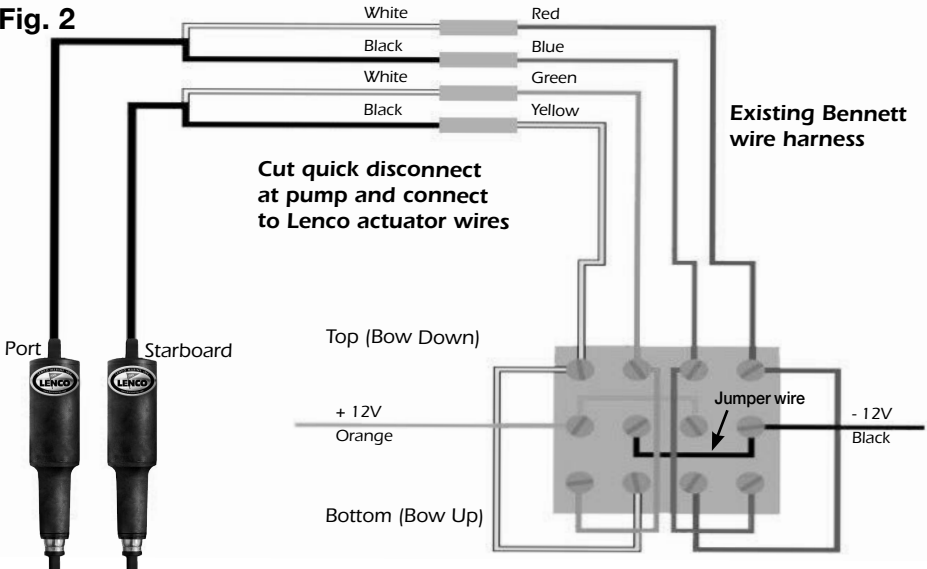

Fig. 2



Lenco Hatch Lift Installation & Operation

Due to the many different variables involved with the numerous applications for Lenco hatch lifts, installation is never the same. Here are some general guidelines that can be of assistance:

- Most powerful when actuator is installed vertically at 90 degrees.
- Lifting capabilities decrease the closer the upper or lower mount is located to the hinge.
- The further from a vertical position the less lifting capability. When retracted, **DO NOT** position hatch lift at an angle less than 45 degrees.
- Dual hatch lift systems are recommended for hatches over 500 lbs (226.79 kg) of force, but not to exceed 1000 lbs of force.
- Lenco hatch lifts are designed around a ball screw that spins freely when hatch is fully open or closed.
- **The hatch lift must be allowed to free spin at both ends of its stroke or it will continue to push or pull against any resistance potentially damaging the hatch lift or the hatch itself.**
- Failure to make accurate measurements could cause damage to hatch lift or the hatch itself.
- Lenco hatch lifts are water resistant.
- Lenco hatch lifts will not drift.
- Lenco hatch lifts are offered in both 12 and 24 volts.

| 12V Part Number | L. O. A. Retracted | Approx. Stroke | L. O. A. Extended |
|-----------------|--------------------|----------------|-------------------|
| 20760-001 | 15" | 4" | 19" |
| 20764-001 | 20" | 8" | 28" |
| 20766-001 | 24" | 8" | 32" |
| 20768-001 | 24" | 12" | 36" |
| 20770-001 | 29" | 12" | 41" |
| 20774-001 | 29" | 16" | 45" |
| 20776-001 | 33" | 16" | 49" |
| 20778-001 | 33" | 20" | 53" |
| 20780-001 | 37" | 20" | 57" |
| 20782-001 | 37" | 24" | 61" |
| 20784-001 | 41" | 24" | 65" |

L.O.A. MEASURED FROM BRACKET TO BRACKET

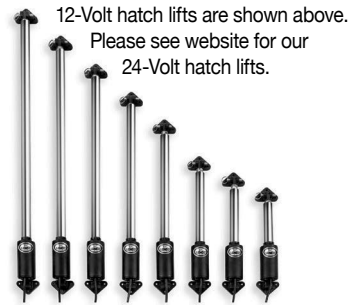

OPERATION

The function of the Lenco Hatch Lift System is simple. Since the hatch lift is based around a ball screw, it is able to push a heavy load and remain at a constant position. To raise a load, extend the hatch lift by pressing on the upper part of the switch. To lower a load, retract the hatch lift by pressing the lower part of the switch. In case of power failure, Lenco hatch lifts are supplied with two clevis pins at the mounting brackets. To pull this pin out while the hatch is closed, you can: A) Rig a cable to pin and rig to a point outside of the hatch. B) Install an inspection plate where the pin will be accessible. C) Install Lenco's hatch lift slide bracket (Part # 70381-001). This will allow you to pull the hatch open 5" (12.7 cm) in order to remove the bolt.

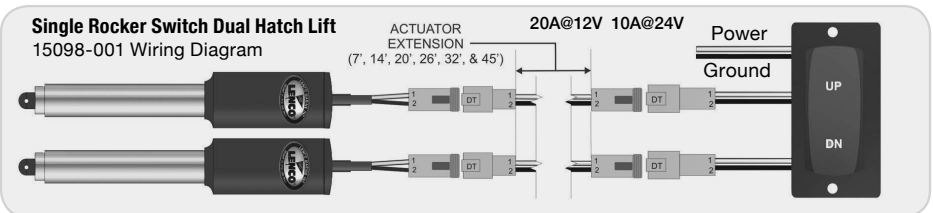
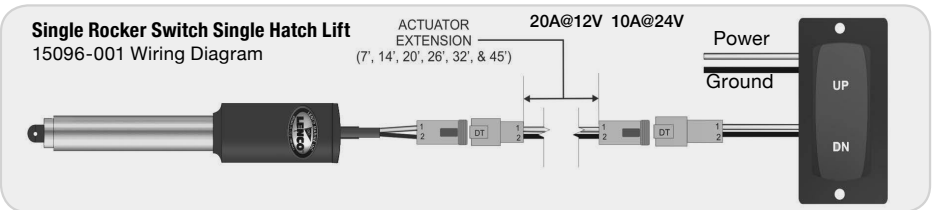

Lenco Hatch Lift Mounting

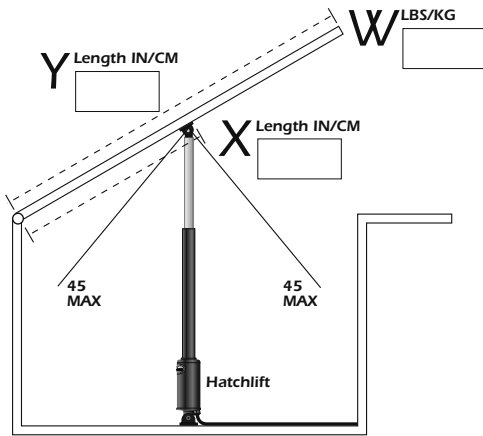

$$Y \times W \div X = \text{Force}$$

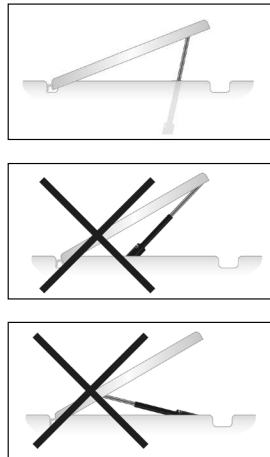

1. Follow the chart above to figure out load on the hatch lift. Maximum load is 500 lbs. (226.8 kg)
 Y = Total length of hatch
 X = Length from the hinge to the hatch lift mounting point
 W = Weight of the hatch to be lifted
2. Determine the angle of the hatch lift mount. Do not exceed 45 degrees from center.
3. Mount the hatch lift on the desired location as per the above instructions.
Important: It may be necessary to

- shim the upper or lower mounting bracket up or down so the hatch does not bind when fully closed. The hatch lift does not stop pulling until it has reached its fully closed position. If the hatch fully closes before the hatch lift is fully retracted, it will cause damage to the lift or the mounting hardware. Shim the hatch lift with stainless washers for small amounts of length. Use Lenco shim part #50015-002D for lengths greater than 1/8" (3.2 mm).
4. Wire to switch according to the hatch lift wiring diagram on page 19.

SYSTEM PARTS

| | |
|--|-------------------------------|
| 1 Upper Mounting brackets | #50014-001D (119) |
| 2 Lower Mounting brackets | #50014-001D (119) |
| 3 Clevis pins | #60101-001D (121SS) |
| 4 Single rocker switch for single HL application | #15096-001 (optional) |
| 5 Single rocker switch for dual HL application | #15098-001 (optional) |
| 6 Shim - 7° (2 Needed per 1/2") | #50015-002D (118S) (optional) |
| 7 Slide bracket | #70381-001 (HLSB) (optional) |

Lenco Airboat Trim Tabs Installation Instructions

Please read these instructions carefully before installing your Lenco Airboat Trim Tab.

Installation of Trim Tab Blade

1. The Airboat trim tab is always mounted in the center of the boats transom with the bottom of the hinge $3/8"$ (.95 cm) up from the bottom of the transom. (see Fig. 1).

Note: The reason the hinge knuckle is mounted $3/8"$ (.95 cm) from the bottom of the transom is to allow water to travel along the bottom of the boat and create lift when it is redirected by the trim tab blade. The tab is also mounted in this manner for protection while on a boat trailer or when being dry-stored.

On aluminum hulls, mount the hinge high enough so that when the trim tab is deployed, it clears the bottom lip that extends past the transom.

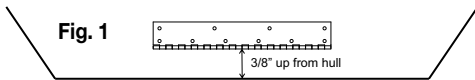

2. Using a $1/4"$ (.64 cm) drill bit, drill all hinge holes through the transom. Through-bolt the hinge to the transom using the $1/4"$ - 20 MS pan head phillips screws, nuts, and washers provided. Use Marine adhesive caulking to seal all holes and bed the hinge and screws.

Installing Upper Mounting Bracket & Actuator

1. To properly position the upper mounting against the transom, first fully extend the Lenco actuator as far as it will go. You can do this by turning the actuator counter clockwise until it free wheels at the end of its stroke, OR, touch the power wires to a 12V DC Source (Example: a drill battery). Once the actuator is fully extended, loosely attach the upper mounting bracket to the top of the actuator, and the bottom of the actuator to the lower mounting c-channel's first hole (the one closest to the hinge) using the bolts, spacers, and nuts provided. Then position the trim tab to the desired level below the bottom of the boat. We recommend $2"$ - $3"$ measured from a straight edge or level from the bottom of the boat to the trailing edge of the trim tab (see Fig. 2).

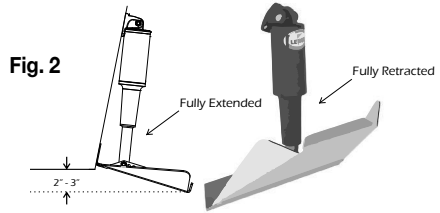

When the trim tab is at the appropriate level, transfer (trace) the outer shape of the upper mounting bracket onto the transom. The upper mounting bracket should be marked where it lays naturally against the transom to prevent binding during functioning of the trim tabs.

Note: Do not adjust the upper mounting bracket to the right or left, as this will cause binding. Allow the bracket to come to rest at its natural position.

2. Remove the upper mounting bracket from the actuator and align to the previously marked location to mark the upper mounting bracket screw hole locations and cable hole location. Using a $1/4"$ (.64 cm) drill bit, drill the three previously marked screw hole locations to a depth of $1-1/4"$ (3.17 cm).

WARNING: Be sure to check inside the hull before drilling the $3/8"$ (.95 cm) cable hole.

Note: When drilling out the screw hole pattern for the upper mounting bracket, you may drill through the transom. The screws should be installed with Marine adhesive caulking which will seal the holes when installed.

3. If all is clear, use the $3/8"$ (.95 cm) drill bit and drill the previously marked cable hole completely through the transom. Insert the actuator cable through the appropriate hole in the upper mounting bracket until the mount reaches the actuator. Insert the actuator cable through the gland seal until it reaches the rear of the upper mounting bracket.

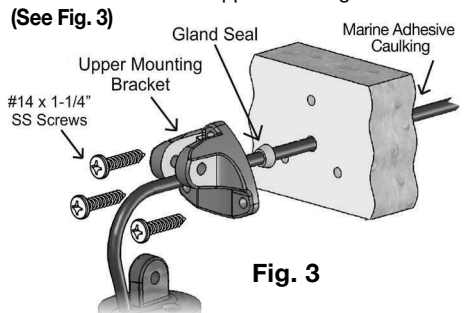

If, however, you are prevented from drilling a hole through the transom at the bracket location, using the 3/8" (.95 cm) drill bit, simply drill a 3/8" (.95 cm) hole 4" to 5" (10.16 to 12.7 cm) above the waterline and insert the cable. Cover the hole and cable with our suggested 15084-001 Remote Gland Seal Kit (see figure 4).

Fig. 4

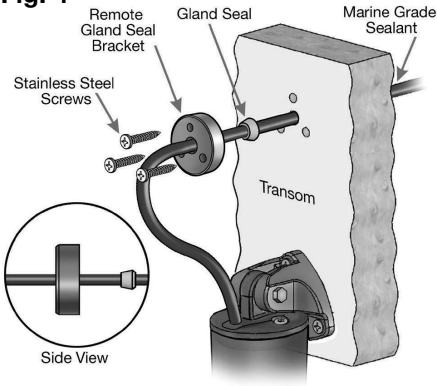

4. Insert the actuator cable through the transom. With the actuator loosely supported, insert the provided 1/4"-20 x 7/8" pan head phillips screws through the upper mounting bracket holes and into the transom and loosely attach the washers and nut.

MAKE SURE TO LEAVE THE SCREWS ONLY PARTIALLY INSTALLED.

5. Insert the actuator clevis (mounting ear) into the upper mounting bracket, and hold the actuator in the approximate installed position. Pass the actuator cable through the transom, removing slack on the cable until it looks like the installation on Fig 3. Finish installing the previously started 1/4"-20 x 7/8" pan head phillips screws, nuts, and washers through the upper mounting bracket and into the transom.

We recommend using Marine adhesive caulking to bed the upper mounting bracket and screws.

DO NOT OVERTIGHTEN.

6. Attach and secure the actuator to the upper mounting bracket using the 5/16-18 X 1-3/4" (4.45 cm) large hex head bolt and 5/16-18 (.79 cm) hex nut provided.

We recommend using Marine adhesive caulking to seal the cable hole on the inside of the transom.

7. Attach the switch Deutsch connector to the Actuator Deutsch connector via the Actuator Extension harness as seen in the diagram below. (See Fig. 5)

Fig. 5

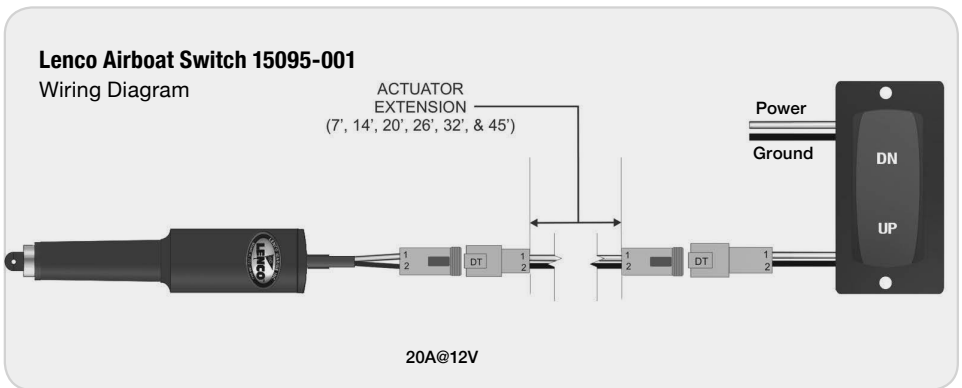

General Troubleshooting

| Symptom | Possible Cause | Remedy |
|---|---|---|
| Switch key pad is unresponsive | Orange wire not connected (Orange wire must be connected on all systems except Rocker style switches) | Make sure the orange wire is connected to a Key switch, or on/off switch.  |
| | No Voltage from the battery | Check the in line fuse/breaker making sure it's not blown or tripped. See switch wiring diagram for fuse/breaker size. (see Fig. 2) |
| | Low Voltage from the battery | Test the battery and make sure it's fully charged. If not, charge battery. |
| | Deutsch Power Pigtail plug is not properly connected | Make sure the Deutsch Power Pigtail plug (see Fig. 3) , male and female, are seated until they click together. Verify the Red (positive) wire and Black (negative) wire is matching up. |
| | Actuators are not connected | Make sure the Actuator Deutsch plugs are fully seated until they click together (see THINGS TO CONSIDER WHEN TROUBLESHOOTING for actuator testing). |
| | The black Molex plug is not seated (only for Two-Piece and Flybridge Kits) | Check the Molex plug on the back of key pad, making sure the connection is good (see Fig. 4) . (Flybridge only) Check Molex plug (see Fig. 4) on back of the flybridge key pad, making sure connection is good. If you remove key pad from upper station and plug directly into the Molex cable coming off the controller, you can verify that the extension cable is not the issue. |
| Every other LED light is illuminated on the key pad | The Actuator is not connected | Make sure the Actuator Deutsch plugs are fully seated until they click together (see THINGS TO CONSIDER WHEN TROUBLESHOOTING for actuator testing). |
| LED lights are scrolling on the 4 lower right corner lights | Low battery voltage | Charge your battery. |

Self-Check for the LED Indicator

PORT SIDE FAULT



STARBOARD FAULT



BOTH SIDES FAULT



For more information on additional troubleshooting, or any the Lenco Marine products please visit our website: www.lencomarine.com



| Symptom | Possible Cause | Remedy |
|--|---------------------------------|---|
| One or more Actuators are unresponsive | Deutsch plugs are not connected | Make sure the Actuator Deutsch plugs are fully seated until they click together (see THINGS TO CONSIDER WHEN TROUBLESHOOTING for actuator testing). |
| | Bad Actuator(s) | Test the Actuator(s) by disassembling the Deutsch plug connection inside the transom and test each actuator using direct power (see Fig. 5) (also see THINGS TO CONSIDER WHEN TROUBLESHOOTING for actuator testing). |
| | Key pad button(s) failure | Test the Actuator(s) by disassembling the Deutsch plug at the back of the controller. Test each actuator to direct power (see Fig. 5) (also see THINGS TO CONSIDER WHEN TROUBLESHOOTING for actuator testing). If both actuators work, call Lenco Marine for further assistance. |

Fig. 1



Orange wire connection

Fig. 2



Fuse holder

Fig. 3



Deutsch Power Pigtail plug

Fig. 4



Molex plug

Fig. 5

LENCO ACTUATOR DIRECT POWER TEST



Remove the orange wedge by lifting the wedge from the connector with a small flat head screwdriver or Deutsch connector tool.

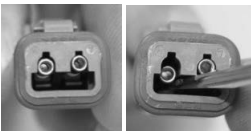

Remove the wire leads from the connector by depressing the small latch inside the connector housing.



Extend the Actuator:
 White Terminal to Positive (+) Battery Terminal.
 Black Terminal to Negative (-) Battery Terminal.

THINGS TO CONSIDER WHEN TROUBLESHOOTING:

1. Make sure you check all connections and wiring for corrosion, as this can cause unforeseen problems.
2. Make sure you have a fully charged battery and connectors are free of corrosion.
3. Lenco Marine Actuators use a simple reverse polarity motor. To test an actuator, apply the white wire to the positive post and black wire to the negative post of a battery, this will extend the actuator. If you reverse the two wire connections, it will retract. The actuator's white and black wires can be applied directly to power. If the Actuator(s) does not move, replace the actuator(s).

NOTE: for DUAL ACTUATOR TAB, you MUST remove lower mounting bolts on both actuators, so they can move independently to test.

Warranty Policy

Lenco Marine LLC warrants its new products to be free from defects in material and workmanship for the following periods:

- **Trim Tab Systems:** 5 years from the original date of purchase. *(Limited)*
- **Ski/Wake/Tow Systems:** 3 years from the original date of purchase.
- **Retro Fit Kits:** 5 years from the original date of purchase.
- **Electric Hatch-Lift:** 2 years from the original date of purchase.
- **Electrical Switches:** 3 years from the original date of purchase.



Lenco Marine LLC will, at our sole discretion, repair or replace any product that has proven to meet warranty eligibility in accordance with this policy. Any replacement or refurbished product will be warranted in accordance with this policy for the unexpired balance of the warranty period on the original product. Policies regarding freight and other charges are as follows:

- Freight charges associated with warranty products required to be returned to Lenco Marine LLC will be the responsibility of the customer.
- Charges associated with warranty product that is damaged during its return to Lenco Marine LLC due to improper packaging will be the responsibility of the customer.
- Once the product is proven to meet warranty eligibility, Lenco Marine LLC will be responsible for standard return freight within the continental United States.
- All freight charges from warranty claims submitted from outside the continental United States are the sole responsibility of the customer.
- Lenco Marine LLC is not responsible for charges related to the removal of such product, including haul out, labor, or any other miscellaneous charge(s).
- This warranty is not transferable.

This policy does not apply to product that has been:

- Damaged due to improper installation or operation.
- Damaged due to abuse or neglect.
- Modified from its original state without the express written consent from Lenco Marine LLC.
- Used on a vessel where the engine horsepower exceeds the recommendation of the boat manufacturer.
- Damage due to Electrolysis.

The warranty period for products used commercially, or in any rental or other income producing activity will be 90 days from the original date of purchase.

The foregoing is in lieu of any and all other warranties, expressed or implied, including any warranty of merchantability or fitness for a particular purpose. There are no other warranties which extend beyond that set forth above. Lenco Marine LLC., reserves the right to void any warranty claim if the part is opened or repair was attempted, without the express written consent from Lenco Marine LLC.

Switch Templates

Integrated & Two Piece Switch (Fig 1)

Align the centering bit of a 2 1/16" (5.24 cm) hole saw with the cross hairs in the center of the dashed circular perimeter and drill straight down through the helm, providing additional clearance for switch and electrical connection.

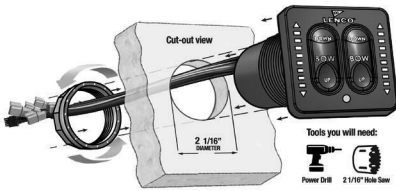
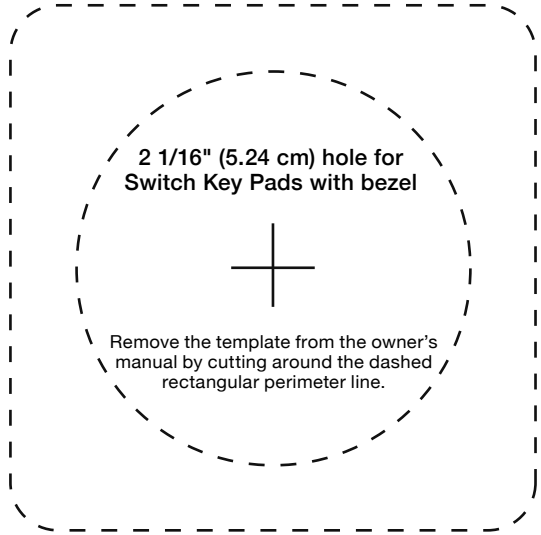

Fig 1



122 Double Rocker Switch (Fig 2)

Align the centering bit of a 2 1/4" (5.715 cm) hole saw with the cross hairs in the center of the dashed circular perimeter and drill straight down through the helm, providing additional clearance for switch and electrical connection.

Before drilling the four switch mounting holes, drill a small pilot hole using a 1/8" (.32 cm) diameter drill bit. Make sure pilot holes are straight.



Fig 2

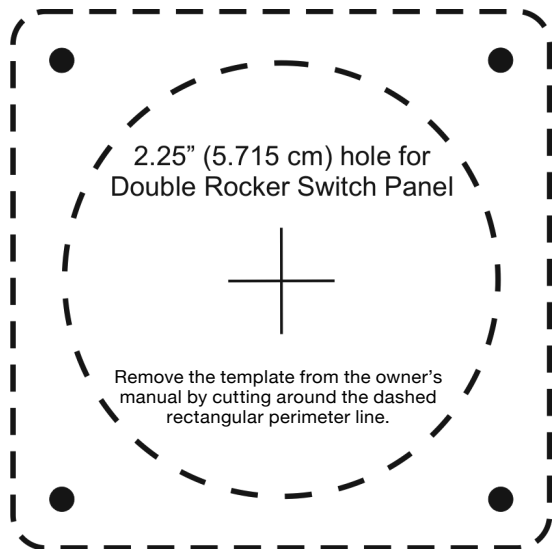

The contents of this manual are subject to change without notice and do not constitute a commitment on the part of Lenco Marine LLC. Every effort has been made to ensure the accuracy of this document. However due to ongoing product improvement and revision, Lenco Marine LLC cannot guarantee the accuracy of printed material after date of publication nor can it accept the responsibility for errors or omissions. Lenco Marine LLC will update and revise this document as needed. Reproduction or duplication of the manual, or any part thereof is prohibited without the expressed written permission of Lenco Marine LLC, Inc. All rights reserved. © 2019 Lenco Marine LLC.



For more information on any of our products, please visit our website: www.lencomarine.com

Time to get your feet wet



AUTO GLIDE™
BOAT LEVELING SYSTEM



So you have been thinking about it for a while...maybe it's time to get your feet wet and start using Lenco's Auto Glide Boat Leveling System. Whether you're an experienced boater, or a beginner, the Auto Glide will help take your mind off of balancing your boat, and back onto balancing your time on the water.



WE MAKE THE BEST BOATS BETTER!

4700 SE Municipal Court | Stuart, FL 34997 | 772-288-2662 | www.lencoautoglide.com | www.lencomarine.com