

12 V BULB
LAMPADINA 12 V

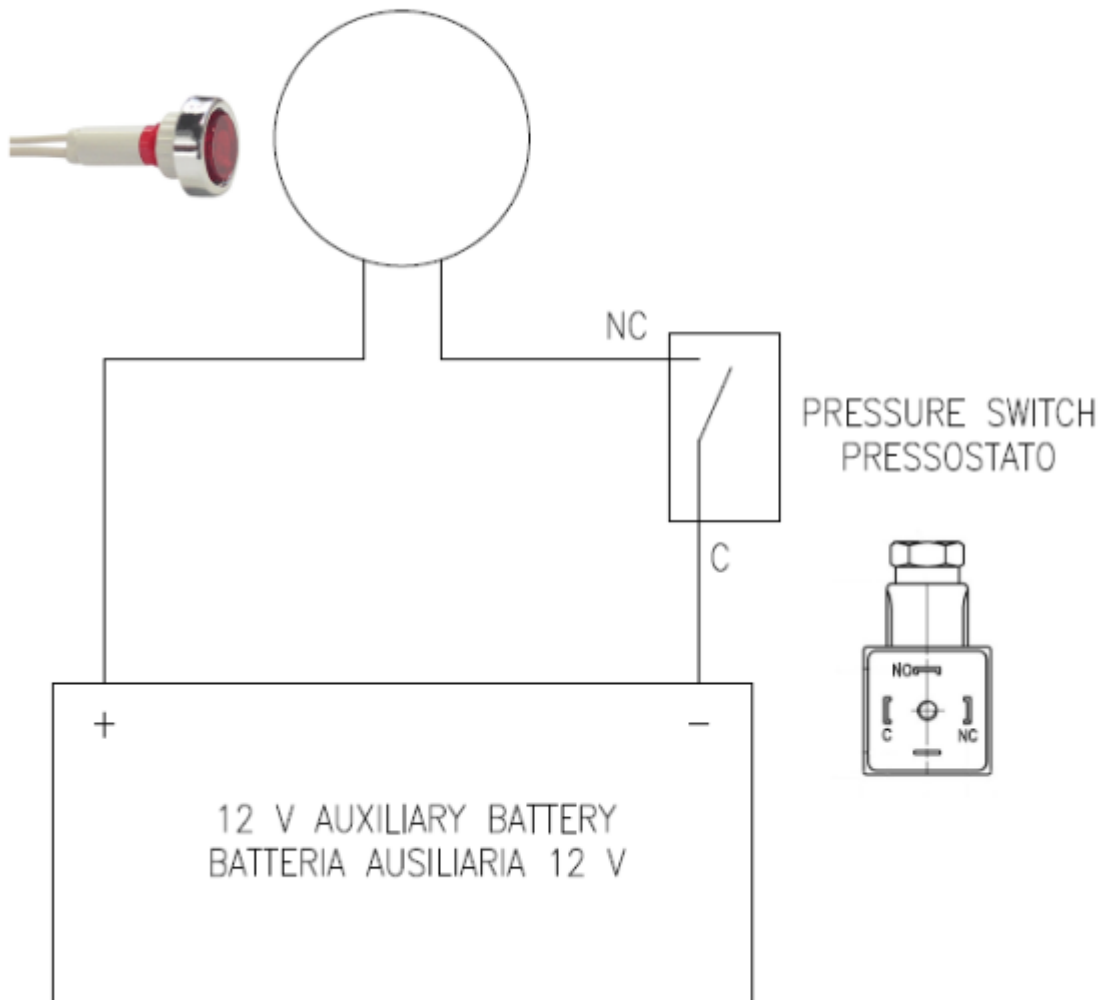

FIREKILL SYSTEMS 1-3-6-9-12 kg POWDER ABC

RINA APPROVED ISO 9094:2015 No. 525310CS/002- ISO 14520

EC certificate

Description:

FIREKILL is an fixed extinguishing system composed by a pressurized cylinder filled with POWDER ABC. It is equipped with manual remote control and equipped with a thermosensitive bulb, at 93°C (or on request at 68°). If fire system is automatic actuated, it must be equipped with pressure switch to check charge. FIREKILL has a versatile valve, completely automatic without use of any source of energy. It has a manual remote control pull cable or on request a remote battery control electric box actuator. Moreover it is possible to connect a control panel that controls the smoke detectors. FIREKILL unique valve has two outlet diam. 3/8" pipes, a maximum of 4 nozzles, it may distribute the jet with precision in the effective point of the fire risk. Assembly without necessity to thread tubes, extremely easy and quick. Suitable also to protect mixers of varnishes, garages, flammable liquids storage, etc.

Extinguishing agent

Dry chemical powder ABC 30% is produced in according to EN 615 (1995) and ISO 9001 quality control. The basic components of dry powder are ammonium phosphate and ammonium sulphate with special silicones additives enabling easy flow discharge and avoiding any checking process. Dry powder is not corrosive, not abrasive, non toxic for humans and animals. Note: other kinds of powder may be used ABC 30% ask our technical office for compatibility.

The kit includes following parts:

- Steel cylinder CE;
- Rapid discharge valve made of chromed brass M30x1,5 with manometer and thermosensitive bulb at 93°C (5);
- Extinguishing agent;
- Pipe with fast connection couplings (3);
- Discharge nozzles made of chromed brass (1);
- Remote control with handle (4+2);
- Electric actuator (6) (optional) which connects the remote control to an automatic control panel;
- Wall bracket (8);

Use:

- 1) Pull the handle (2) in case of fire or
- 2) (If installed) Push the button on the control box to activate the pyro. actuator;
- 3) The temperature higher than sprinkler bulb temperature will activate the FIREKILL.

Operation:

The unit is pressurized at 14 bar at 20°C.

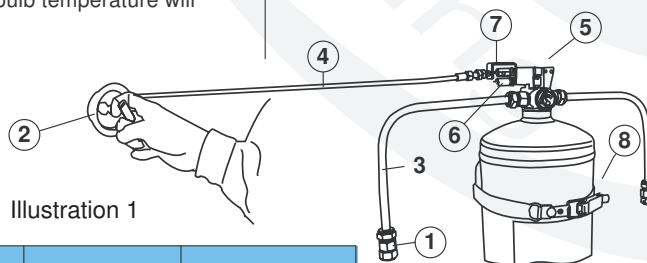

Illustration 1

Installation (illustration 1)

The FIREKILL must be hanged to its metal wall bracket inside or outside the protected area. Check the pressure looking at the pressure gauge the needle must be in green sector. Fix the pipes (3) from the FIREKILL body to the area to be protected, connect the discharge nozzles (1) at the end of the pipes (3), near the dangerous point or the protected area. Fix the remote control cable (4) to the hexagon (7) and to the remote control handle (2). Safety pin (5) must be pulled out at the end of all above operations. Now the FIRE KILL is ready to work. FIREKILL can be activated manually by pulling the remote control handle (2), otherwise automatically when the bursting temperature of Sprinkler bulb is reached. Bulb glass can be supplied with bursting temperature at 93 or 68°C. The electric actuator (6) can be supplied on request. It can be connected with an emergency control push button or through a control panel in case there is an automatic detection system. A standard detection system for our firekill system is composed by:

- Low pressure switch cod. 23024, which directly indicates alarm leaks or discharging In case of need of the low pressure switch, please inform the manufacturer before ordering, so we can mount it before the pressurization process;
- Control panel which enable the perfect control of the full system cod. 23022 or 23022_1 or 23023;
- Thermosensitive detectors, cables or candel.

The electric actuator is a pyrotechnical charge, 5 years guaranteed at a work temperature from -20°C up to +80°C and humidity of 100%. The pyrotechnical charge can work with minimum 12 V tension and 1 A current.

Electrical connection:

The electrical connection to the pyrotechnical actuator must be made by a shielded wire; it must be connected directly from battery to the emergency push-button (Control Box Cod. 23022, 23022_1 or 23023) and to the actuator. Avoid to connect the actuator in different positions (like fuses panel) to avoid accidental activations.

Torque force:

The valve is screwed down to the tank at the prefixed torque between 5 and 6 Kg/m (i.e. between 50 and 60 Nm).

Mount only in vertical position. For horizontal or upside need, contact factory when ordering

Code	Charge kg	Protected zone m³	Q.ty nozzle	Max pipe length mt x 2
15241	1	1.7	2	2
15227	3	5.1	2	4
15228	6	10	2	5
15226	9	15	4	6
15229	12	20	4	8

On request it will be available even 2 and 4 kg

Replacement of the electric actuator (illustration 2)

Replacement due to 5 years maintenance the electric actuator must be replaced with a new one as described above:

- a) unscrew the actuator (1);
- b) disconnett
- c) screw the new actuator checking that the part outside measure will be 2 mm.

Replacement due to the explosion of the pyrotechnical change:

- a) unscrew the actuator (1);
- b) unscrew the valve from the cylinder;
- c) extract the piston (2) and replace the O-ring (3);
- d) after having put the piston in the valve, screw the valve on the cylinder;
- e) put the new bulb (4) in the valve;
- f) pull outside the nut (5) and turn the leverage (6) till it is positioned on the bulb. Release the nut (5) (be sure that the leverage (6) is locked) replace the cartridge with a new one and screw it till the outside part will be between 2 mm.

the one

Use Remarks

- 1) the extinguisher can be used on electric fires (control panel or switch boards).
- 2) ventilate room after gas discharge / intervention.
- 3) refill and recharge the unit even partially used.

Maintenance and disposal:

Maintenance, handling, storage and disposal of the unit must be done following local regulations. A company who makes above activities and disposal of extinguisher agent should be authorized for such works.

Periodically check that pressure gauge indicators is on the green field, that means extinguisher is still well pressurized and ready to be used.

If pressure gauge indicator is on red field, refer to authorized maintenance company.

Periodic inspection, servicing and tests:

The maintenance of unit should be done at least every 6 months, or according to local law.

Hydraulic tests of extinguisher body must be done every 12 years.

PRESSURE SWITCH (cod. 23024) PRESET AT 5 bar

Low pressure switch cod. 23024, which directly indicates alarm leaks or discharging.



Code 23024

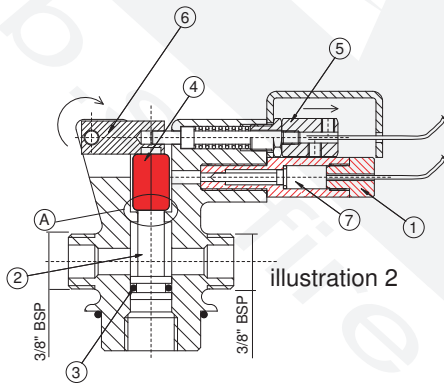
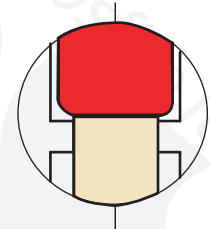

illustration 2

Attention (detail "A"):

During the maintenance of the valve check as well that the piston is passing the body valve as detail "A"

Detail "A"



INSTRUCTIONS FOR THE USER

PHASE	EVENT	DA NGER	SUGGESTIONS AND PRECAUTIONS	MEASURES
TRANSPORT AND INSTALLATION	FALL	BUMP	Carry in container which protects the product from bump.	In case of dent, give the product back to the maker for control.
OPERATION	OVER-PRESSURE WEAR/CORROSION	BURSTING/ REDUCING OF THE THICKNESS	Pressurize extinguishers at 14 bar at 20°C. The pressurization must be done by means of a well-tuned pressure reducer. Avoid: - Bump which can damage the painting. - Washing and contact with corrosive materials.	If corrosion is pointed out please call the maintenance company for an immediate hydraulic test.
MAINTENANCE	IMPROPER DEPRESSURIZATION	VIOLENT CAST OF COMPONENT OR PART OF THEM	The maintenance must be done by qualified company (in extinguishers maintenance).	The maintenance of the extinguisher must be done according to the local regulation.
			The disposal must be done by qualified company (in chemical products disposal).	The disposal must be done by qualified and authorized company only who make it according to the local regulations In case of contact with POWDER, wash immediately with a large amount of water.

ACCESSORIES ON REQUEST FIREKILL SYSTEMS

On request the firekill system can be electrically activated with automatical detection system.

In the scheme below you can see an example of automatical detection system for firekill system with all its options available

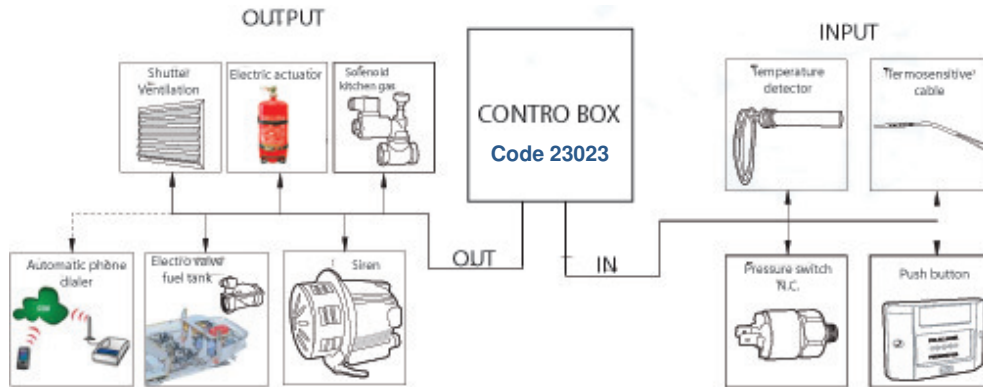

Electric actuator (cod. 43001)

It can be connected with an emergency control push button or through a control panel in case there is an automatic detection system.

The electric actuator is a pyrotechnical charge, 5 years guaranteed at a work temperature from -20°C up to +80°C and humidity of 100%. The pyrotechnical charge can work with minimum 12 V tension and 1 A current.

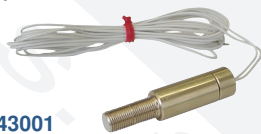

Code 43001

MARINE CONTROL BOX (cod. 23023)

The central unit and control unit are manufactured with materials immune to the marine environment and supplied in IP65 version. Furthermore, the chassis ensures adequate heat dissipation which allows long periods of operation. It controls all the above illustrated device. It can be programmed in 4 languages.

Code 23023
Central unit CPU



Dash board remote unit



TEMPERATURE DETECTOR (cod. 47038 - 47019)

The apparatus consists of two contacts mounted on two curved strips of nickel-iron, the contacts are electronically isolated from the strips, however, a complex that is called "crew" is in turn mounted in stress conditions in a sheath consisting of a tube extruded AISI. The temperature at which the sheath is taken. Any change in temperature dilates the sheath, which thus increases the tension that it exerts on the plate, switching the contact, as appropriate.



Code 47038
preset at 141°C
Code 47019
preset at 68°C

CONTROL BOX (cod. 23022 or 23022_1)

This unit is used in combination with Firekill extinguishing system for boat engine or electrical board.

Led green indicates that circuit is operative

Red light indicates that extinguisher has been discharged.

Alarm audible buzzer included in the units will sound when system has been activated. Remove safety pin, open door, press red button inside to activate discharge.



MINIBEND (cod. 28053)

MINIBEND FOR COPPER AND ALUMINUM PIPE FOR EXT.
 Ø 8 - 10 - 12 mm IDEAL TO BEND FIREKILL PIPES



Code 28053

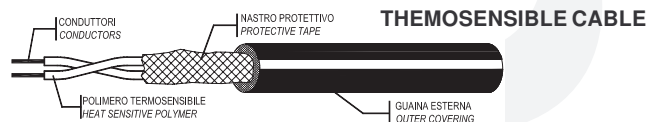

DATI TECNICI - Technical Data :

Temp. di intervento - Alarm Temperature:	180°C - 356°F
Temp. ambiente - Ambient Temperature:	max. 105°C (221 °F)
Materiale Conduttori - Conductors material:	Acciaio - Steel
Resistenza Conduttori Conductors resistance:	~0,66 KΩ/Km
Tensione di lavoro Operative Voltage:	42Vdc, 30Vac max.
Materiale isolamento - Insulation material:	Termosensibile- Heat sensing
Guaina esterna - Outer Jacket	EPC
Diametro cavo- Overall cable dia.:	~ 4mm
Approvazione - Approval:	UL, FM